



Brock's Performance Products • 4064 East Patterson Road • Dayton, OH 45430 • Phone: 937-912-0054 • Fax: 937-912-0062

Installation Instructions for Brock's TiWinder Full Titanium Exhaust System

The *Patent Pending* TiWinder™ Series Exhaust System for the 2006-2010 Kawasaki ZX-14 is a high performance 4-2-1 elliptical side exit exhaust which replaces the stock headers, mid-pipes, and mufflers.

STEP 1: CHECK PACKAGE CONTENTS:

Kawasaki ZX-14 (06-09)			
TITANIUM SIDEWINDER EXHAUST		Bar Code Label	
Description		SKU	Quantity
Header 1 & 2		S-EXPT5603	1
Header 3 & 4		S-EXPT5601	1
Secondary Collector		S-TPTM623SWJ	1
Megaphone		S-TPTM425SWYP	1
Baffle			1
Stainless Steel Flange Collar		EXC090	4
Exhaust Flange		EXF119AL	2
Exhaust Flange		EXF118AL	2
Spring w/ Silicone Sleeve		S-NM-SP-F60	14
Spring Puller		3850-0056	1
Radiator Bracket		SUSW05R	1
Megaphone Bracket		SUSW05T	1
8MM Allen Bolt		CB-08020UCR	1
8MM Washer		PW-0082216UCR	1
Allen Bolt M6-15		CB06015UCR	1
Washer 6x13x1.0		PW-0061310UCR	1
RED Cap			1
Instruction Manual			1
Package w/ Label		22x14x10	1
Actual Weight	7.35 w/o baffle	8.70 lbs w/baffle	
Shipping Weight		10.50 lbs	
Zip-Tie		SYB032	1

STEP 2: PRE-ASSEMBLE HEADERS, COLLECTOR, AND MID-PIPE TO INSURE PROPER FIT BETWEEN ALL PARTS: Brock's Performance carefully inspects each exhaust system prior to shipping, we recommend that you test fit your system prior to installation. Apply WD-40 to the joints to ease assembly, adjustment, and/or disassembly.

STEP 3: REMOVE ZX-14 RIGHT AND LEFT DASHBOARDS: The right and left dashboards are held in place by three fasteners (Figure 4) which are removed with a No. 4 hex head wrench. Note that all dashboard and fairing fasteners have thin plastic washers located between the fastener head and the plastic body work. Be careful to save the plastic washers. To avoid losing fasteners and washers it is recommended that the installer place them in a container once they are removed.



STEP 4: REMOVE ZX-14 LOWER FAIRING: The lower fairing consists of separate right and left side panels, both of which should be removed. The locations of the bolts and plastic push pins holding the fairing in place are illustrated in Figure 5. Details are provided below.

- The plastic push pins is located in the front of the fairing (3), aft of the front tire, and holds the left and right panels together. Remove the plastic push pins using a thin blade screw driver to lift the rivet head. Then pull the rivet from the bodywork. This will release the right panel from the left panel.
- Remove the lower fairing fasteners & washers (1 & 2) on the right fairing panel with a No. 5 hex head wrench.
- Remove the upper fairing fasteners & washers (4, 5, & 6) on the right fairing panel with a No. 4 hex head wrench.
- Note that the top of the fairing incorporates slots into which hooks at the bottom of the mid fairing (red bodywork) fit. These hooks are shown in Figure 8. Pull the bottom of the lower fairing panel away from the bike and then downward to clear the hooks from the slots. The right side lower fairing should now separate easily from the mid-fairing.
- Repeat for the left side lower fairing.

Figure 5: Removal of ZX-14 Lower Fairing

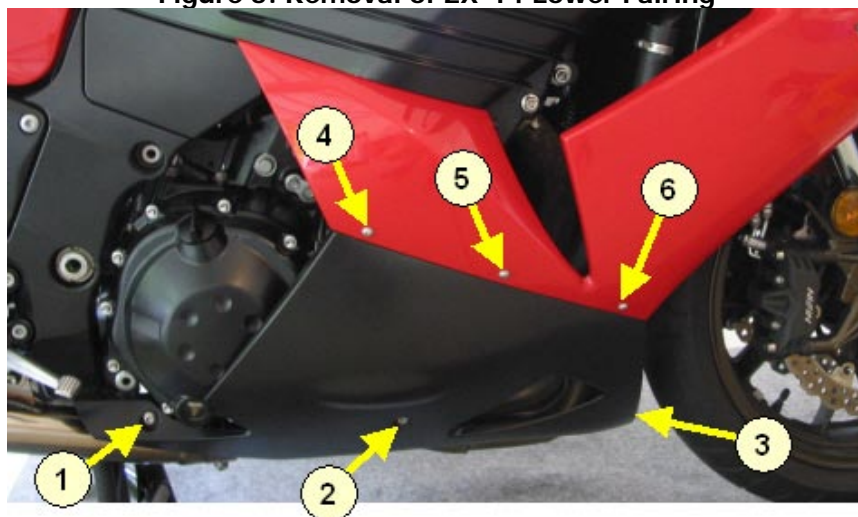

STEP 5: REMOVE THE RIGHT AND LEFT FAIRING GRILLS

- Remove fasteners and washers at positions 1 and 2 (Figure 6) for the right side fairing grill with a No. 5 hex head wrench.
- Remove fastener 3 with a No. 4 hex head wrench.
- The fairing grill is now held in place by three stoppers inserted into the mid-fairing (reference Figure 8). Pull the fairing grill away from the mid-fairing to release and remove.
- Repeat for the left fairing grill.

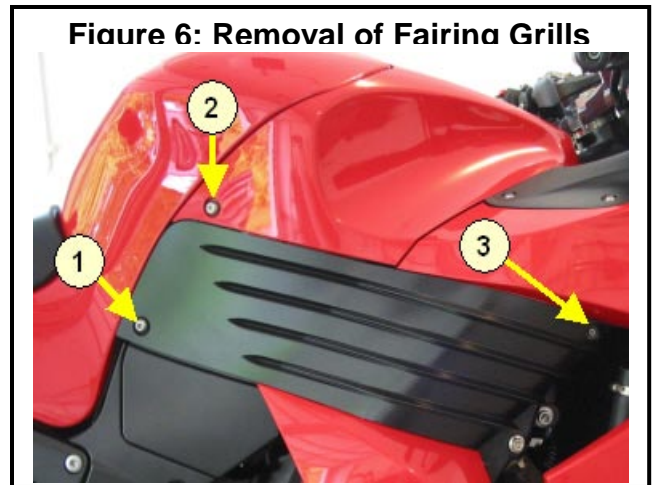

STEP 6: REMOVE THE TANK COVER: The tank cover is held in place by three fasteners (Figure 7). Fastener 1 is located on the right side, fastener 2 on the left side, and fastener 3 at the front of the cover. Note that fasteners 1 and 2 were removed in Step 6. Remove fastener 3 with a No. 5 hex head wrench. The tank is now held in place by stoppers and hooks located on the right and left side (refer to Figure 8). Pull the tank cover evenly in an outward direction on both sides to clear the stoppers and hooks. Then lift the tank cover to remove it from the bike frame.

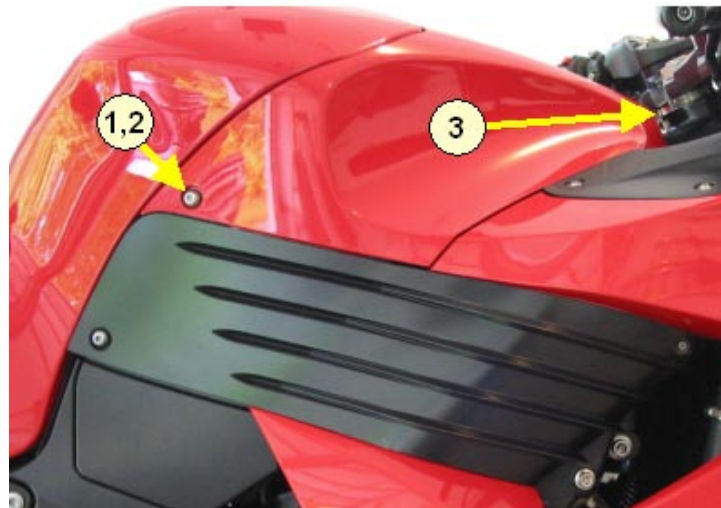
Figure 7: Removal of the Tank Cover

STEP 7: REMOVE THE LEFT AND RIGHT MID-FAIRINGS: Note that the turn signal wiring is connected to the electrical system using a quick connect. When removing the mid-fairing take care not to damage the connector.

- Remove the plastic push pins 4 located under the front of the mid-fairing. Use a pin or small hex head wrench to push the center of the plastic push pins inward. Then remove the rivet using a small flat head screwdriver.
- Remove fasteners at locations 1, 2, and 3 using a No. 4 hex head wrench, Figure 8.
- Pull the lower section of the fairing outward and then pull the fairing downward to release it from the front fairing. Be careful not to pull the fairing too far from the body. While holding the fairing, disconnect the flasher wiring at the quick disconnect. Now remove the fairing.
- If desired, the lower fairing (wing) may be removed. It is held in place by three easy to observe fasteners. Simply remove these fasteners with the appropriate hex head wrench to release the aft fairing from the frame.

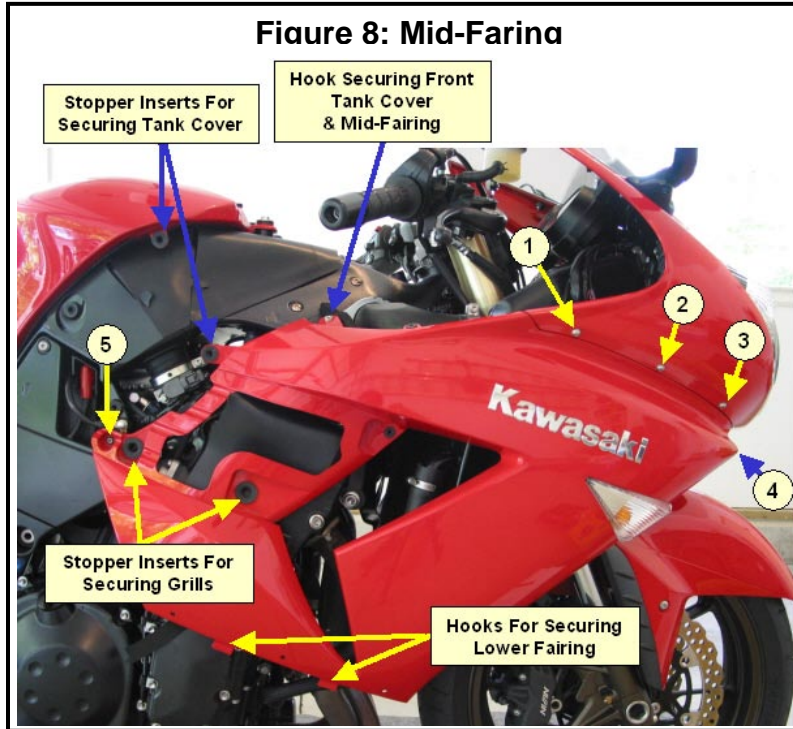

STEP 8: REMOVE THE STOCK RIGHT AND LEFT SIDE MUFFLER BODIES:

- Loosen the forward mid-pipe clamp using a ratchet and 12mm socket, Location 1.
- Remove the bolt at location 2 with a No. 6 hex head wrench (Right side only). Hold the back side nut with a 14 mm open end wrench.
- Remove the nut at location 3 using a ratchet with 14mm socket. Hold the fastener in place with a No. 6 hex head wrench.
- Support the muffler with your leg to release the pressure on the bolt. Remove the bolt.
- Pull the muffler body aft to release it from the forward collector.

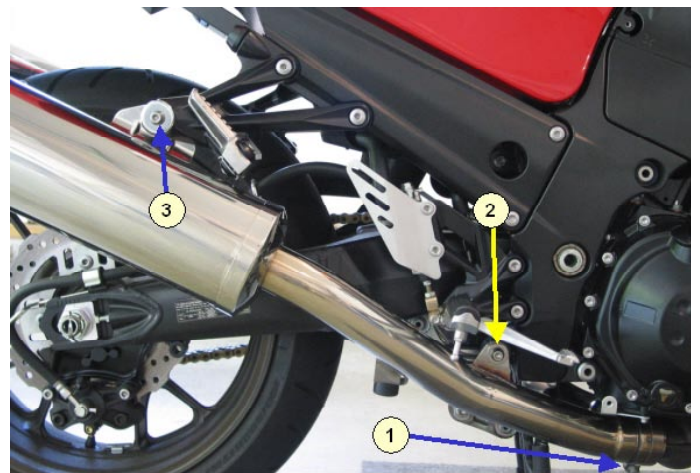

STEP 9: REMOVE THE STOCK HEADER ASSEMBLY:

The procedure described below does not require removal of the radiator. However, the fit is tight and care should be taken to avoid damage to the radiator.

- Remove the radiator bracket holding the bottom of the radiator.
- Remove the header nuts using a ratchet with 12mm socket. Use of an extension will allow easier access to the header bolts. There are two bolts per header. Once the bolts are removed do not allow the header flange to fall and contact the radiator. Carefully move the flange to a position away from the radiator.
- Once all bolts are removed, carefully remove the header from the engine. Avoid contact with the radiator.

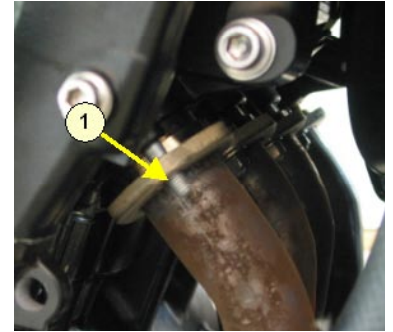

STEP 10: INSTALL THE BIG-CC HEADER MOUNT FLANGES:

Install the four header mount flanges and spigots using nuts from the stock parts. Do not completely tighten the nuts. Leaving them loose will allow easier adjustment when the header pipes are fitted. Nuts will be tightened after the header pipes are installed. Install the springs into the flanges (this step should be done before installing the headers).

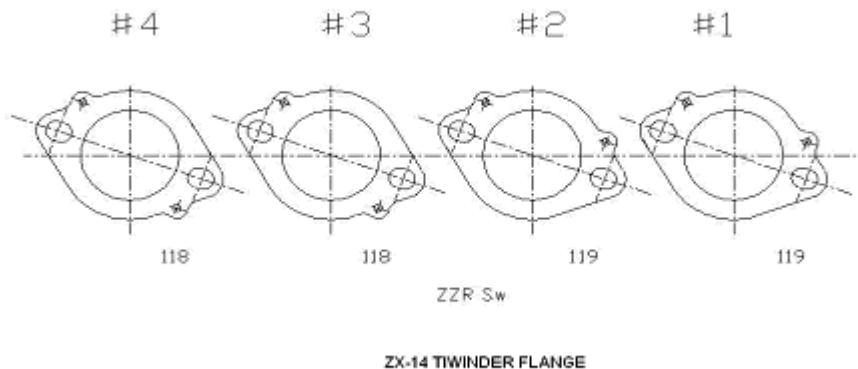

Orient Flanges on Engine as Shown

STEP 11: INSTALL THE RADIATOR BRACKET INCLUDED IN THE KIT:

Remove the stock radiator bracket and install the provided radiator bracket using the m6-15 Allen bolt and m6 washers into the left side bottom of the radiator together with the cooling fan bracket (see the pictures below). The aft side of the bracket can be mounted using the stock bolt onto the pulsing cover.

**STEP 12: INSTALL THE HEADER AND COLLECTOR ASSEMBLY:**

Install the header and collector assembly as a unit, without the mid-pipe. This allows easier manipulation of the assembly to insure proper fit, while avoiding contact with the radiator. Each header inlet will have one mount spring which secures it to the flange. With the exception of the 3rd header flange from the right side, all springs are easily installed after the headers are mounted on the flange spigots. I recommend installing the spring to this 3rd flange prior to installing the header pipes. The spring is located on the left side of the flange, not the right. Prior to installing the headers apply a small amount of Permatex Ultra Copper to the inside of each spigot. This will insure a high temperature seal is created. Be careful; avoid contact with the radiator while installing the header pipes. Once they are in place adjust the pipes as necessary to avoid contact with the radiator. Tighten the flange nuts. *Do not over tighten*. Max recommended torque is 10 ft-lb. Now attach the springs from the flanges to the header pipes.

Do not attach the springs holding the collector to the headers. The headers (1) are attached to the spigots by a spring (2). There is a tight fit between the bottom of the header assembly and the radiator (3), but the two parts should have adequate clearance so that no contact is made. Adjust as required.

STEP 13: INSTALL THE ZIP TIE:

The water hose to the oil cooler is very close to the #2 header tube; use the zip-tie to keep the hose in place and away from #2 headers as shown below. **Note: Do not tighten the zip-tie too much.**

**STEP 14: INSTALL THE MID-PIPE AND MUFFLER:**

- Slip the forward end of the mid-pipe onto the aft end of the collector.
- Remove the right side step bracket, locate the megaphone bracket inside of the step bracket and install them onto the original position together using the stock bolts. Do not tighten fully.
- Locate the megaphone inlet onto the exit of the mid-pipe and install into the megaphone bracket using M8-20 Allen bolt and washer. Do not fully tighten until final adjustments have been made.
- Adjust the assembly by hand as required and then attach mount springs. Tighten the megaphone mount bolt and megaphone bracket mount bolts securely.
- Trim the right side lower fairing as required and install using the stock bolts.

NOTICE

You have now completed installation of the TiWinder Titanium Exhaust System. If you did not purchase a Power Commander, then replace the fairings in reverse order from the fairing removal. If you have a Power Commander installed then you should contact Brock's Performance Products for the appropriate fuel map. It is highly recommended that a Power Commander (or similar mapping system) and appropriate map be installed with any non-stock exhaust system, including both full and slip-on systems.

DO NOT START BIKE UNTIL FAIRINGS HAVE BEEN INSTALLED AND YOU HAVE INSURED A MINIMUM ¼-INCH CLEARANCE BETWEEN THE EXHAUST COMPONENTS AND ALL BODYWORK

Failure to insure proper clearance may result in burned plastic and you burn it, it's your fault. Brock's exhaust system is designed to provide the appropriate clearance. If the minimum clearance is not obtained, remove the springs on the exhaust system, loosen the muffler hanger strap, and adjust until proper clearance is achieved. I personally had no problems and did not need to make any final adjustments.

Brock's Performance Products are designed for Closed-Course Racetrack use ONLY!

For more information go to www.BrocksPerformance.com, click: Installation Instructions

email: Advice@BrocksPerformance.com or call the office at 937-912-0061

Brock's Performance Products policies and warranty information: www.BrocksPerformance.com, click: Policies



Brock's Performance Products • 4064 E. Patterson Road • Dayton, OH 45430 • Phone: 937-912-0054 • Fax: 937-912-0062

2006-2009 ZX-14 AIRBOX BLOCK OFF
Pair valve block off is to prevent "deceleration pop".

1. Remove right side fairing and tank cover in front of gas tank.
2. Remove hose from air box and cut the tapered end straight, see fig. 1.



Fig. 1.

3. Place red plastic block off cap all the way into grommet as shown in fig. 2.



Fig. 2.

4. Insert hose all the way into block off cap as shown in fig. 3. (Make sure hose is in tight).



Fig. 3.

5. Replace fairings.

